

Panasonic

ideas for life

LC-PD1217

For standby power supplies
 Expected trickle life: 6 years at 25°C
 10 years at 20°C



※Contents indicated (including the recycle marking, etc) are subject to change without notice.

■Dimensions(mm)

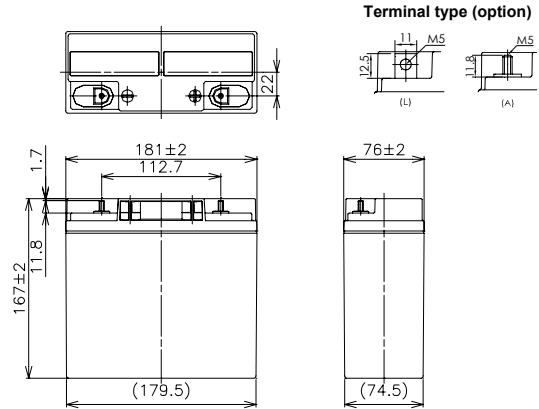

Battery case resin: Flame-retardant (UL94V-0)

■Specification

Nominal Voltage	12V	
Rated Capacity(20HR)	17Ah	
Dimensions	Length	181 mm
	Width	76 mm
	Height	167 mm
	Total height	167 mm
Approx. Mass	5.45 kg	
Terminal	M5 threaded post	

■Characteristics

Capacity (25 °C)	20 hour rate	17Ah
	10 hour rate	16Ah
	3 hour rate	13Ah
	1 hour rate	11Ah
Internal Resistance (25 °C)	Fully charged battery	17 mΩ
Temperature Dependency of Capacity (20 hour rate)	40 °C	102%
	25 °C	100%
	0 °C	85%
	-15 °C	65%
Self Discharge (25 °C)	After 3 months	91%
	After 6 months	82%
	After 12 months	64%

■Duration of discharge vs. discharge current

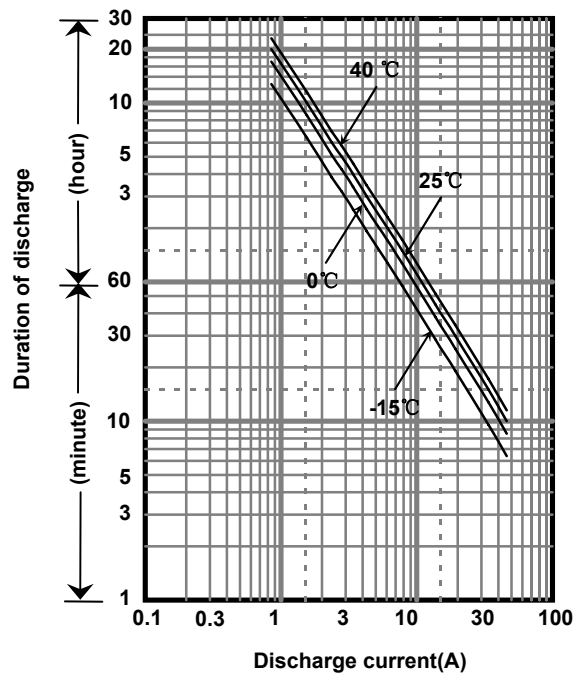

■Watt Table(25°C)

Cut-off V	(Wattage/Battery)														
	5min	10min	15min	20min	30min	45min	1h	1.5h	2h	3h	4h	5h	6h	10h	20h
9.6V	806	526	402	337	251	177	142	97.6	75.5	56.2	43.2	35.6	28.6	19.0	10.3
9.9V	756	516	399	331	249	176	140	95.6	74.9	55.9	42.9	35.4	28.5	18.9	10.3
10.2V	708	502	391	326	246	175	139	93.7	73.0	55.4	42.6	35.1	28.3	18.7	10.2
10.5V	634	465	364	309	240	172	136	91.7	70.4	54.5	42.3	34.8	28.0	18.6	10.2
10.8V	561	415	339	301	232	169	134	89.2	67.1	53.4	41.8	33.9	27.5	18.4	10.1

■Ampere Table(25°C)

Cut-off V	(Ampere/Battery)														
	5min	10min	15min	20min	30min	45min	1h	1.5h	2h	3h	4h	5h	6h	10h	20h
9.6V	72.2	47.0	34.9	29.0	21.5	15.1	12.0	8.26	6.37	4.72	3.61	2.97	2.39	1.65	0.857
9.9V	67.8	46.0	34.7	28.6	21.2	15.0	11.9	8.10	6.33	4.70	3.59	2.95	2.38	1.64	0.855
10.2V	63.5	44.9	34.0	28.1	21.0	14.9	11.7	7.93	6.16	4.65	3.57	2.93	2.36	1.63	0.852
10.5V	56.9	41.6	31.6	26.7	20.5	14.6	11.6	7.77	5.95	4.58	3.54	2.90	2.33	1.62	0.850
10.8V	50.3	37.1	29.5	26.0	19.8	14.4	11.3	7.56	5.67	4.49	3.49	2.83	2.29	1.60	0.845

Charging Method (25°C)

Trickle use	Control voltage:13.6-13.8V Initial current:2.55A or smaller
-------------	--

Cut off voltage

Discharge current	0.850A-3.40A	3.40A-8.50A	8.50A-17.0A	17.0A-34.0A	34.0A-51.0A
Cut off voltage(V)	10.5	10.2	9.9	9.3	8.7

Influence of Temperature on Trickle life

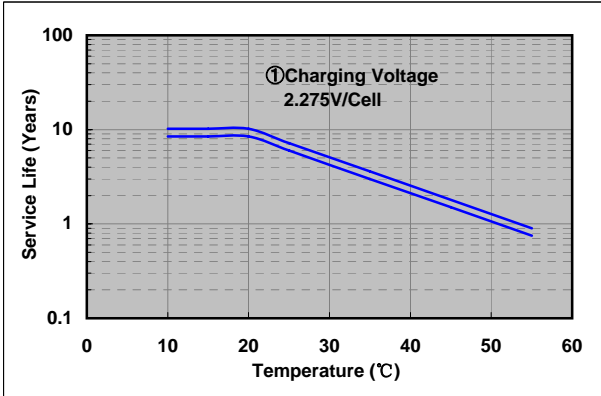

Residual capacity test result

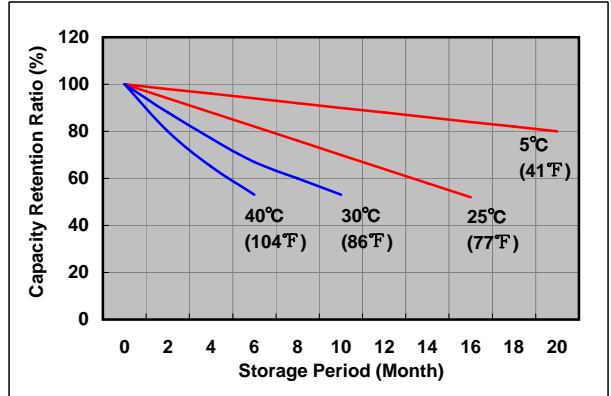

Constant-voltage constant-current charge characteristics for Trickle use

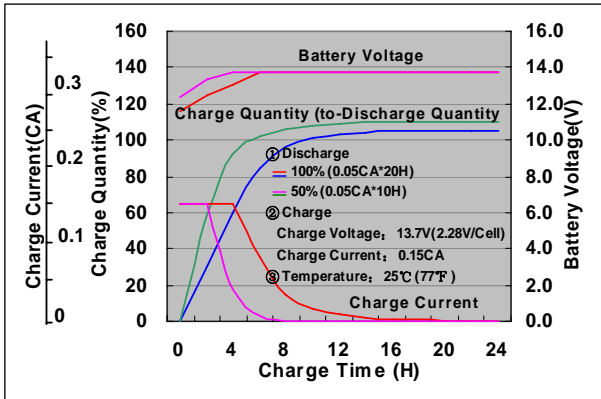

Discharge capacity by temperature and by discharge current

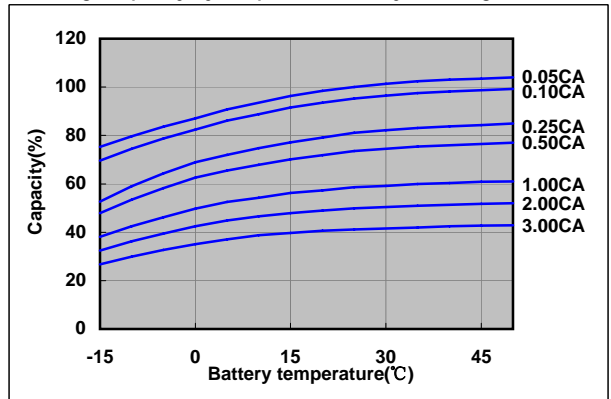

Discharge characteristics(25°C)

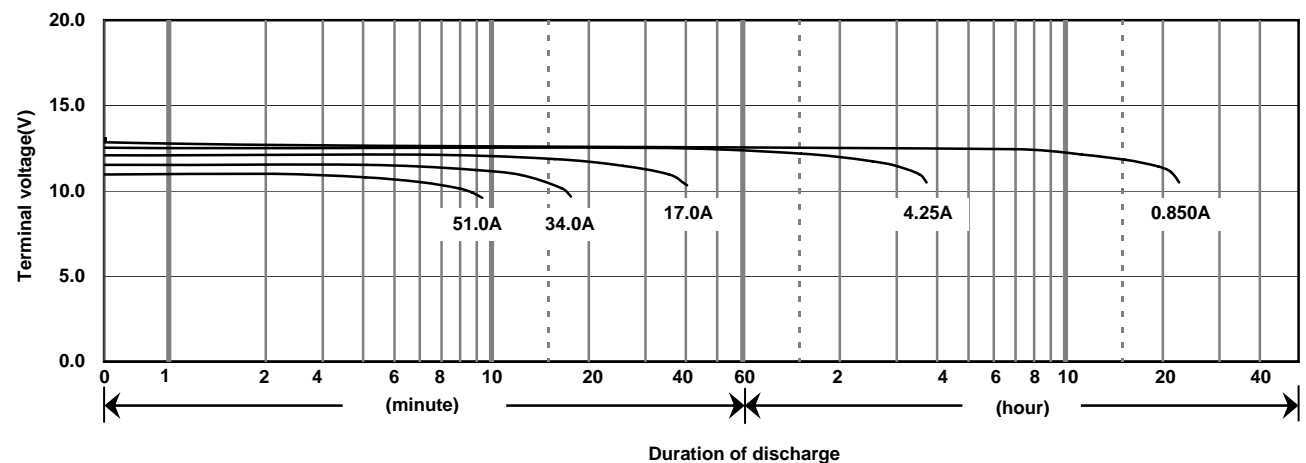

Caution

Due to the potential energy stored in the batteries, Please read 《Precautions for handling the Rechargeable Valve Regulated Lead Acid Batteries》 before using batteries. If improper handling or use of the batteries without understanding 《Precautions for handling the Rechargeable Valve Regulated Lead Acid Batteries》 may result in bodily injury caused by electrolyte leakage, heat generation, or explosion.

Panasonic Storage Battery (Shenyang) Co., Ltd

NO. 51 Kunminghu Street, Shenyang Economic & Technical Development Zone, 110141 China
Tel: 86 24 25818921
Fax: 86 24 62786318
Website: <http://www.panasonicbattery.cn>

2010.03

Mouser Electronics

Authorized Distributor

Click to View Pricing, Inventory, Delivery & Lifecycle Information:

[Panasonic:](#)

[LC-PD1217P](#)