

LC-V1233P

DIMENSIONS (MM)



Contents indicated (including the recycle marking, etc.) are subject to change without notice.

FOR MAIN AND STANDBY POWER SUPPLIES.
EXPECTED TRICKLE DESIGN LIFE: 6 – 9 YEARS AT 20°C
ACCORDING TO EUROBAT.

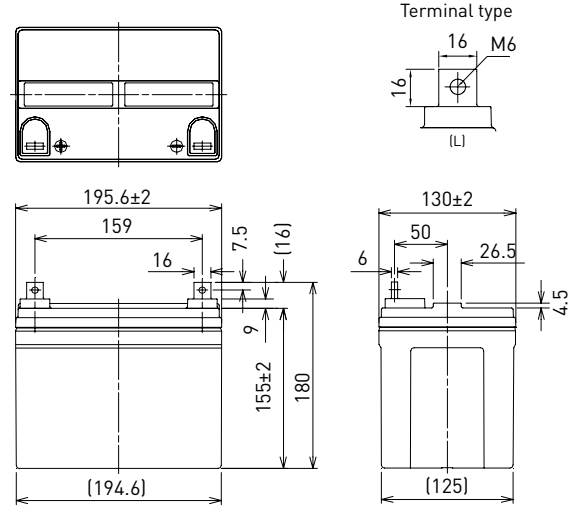

Battery case resin: flame retardant (UL94 V-0)

SPECIFICATIONS		
Name	LC-V1233P	
Nominal voltage	12V	
Nominal capacity (20 hour rate)	33Ah	
Dimensions	Length	195.6mm
	Width	130mm
	Height	180mm
Approx. mass	11.5kg	
Terminal	M6 bolt/nut	
Capacity (25°C)	20 hour rate	33Ah
	10 hour rate	31Ah
	3 hour rate	26Ah
	1 hour rate	22Ah
Impedance	Fully charged battery (25°C)	7mΩ
Temperature dependency of capacity (20 hour rate)	40°C	102%
	25°C	100%
	0°C	85%
	-15°C	65%
Remaining capacity (25°C)	After 3 month	91%
	After 6 month	82%
	After 12 month	64%

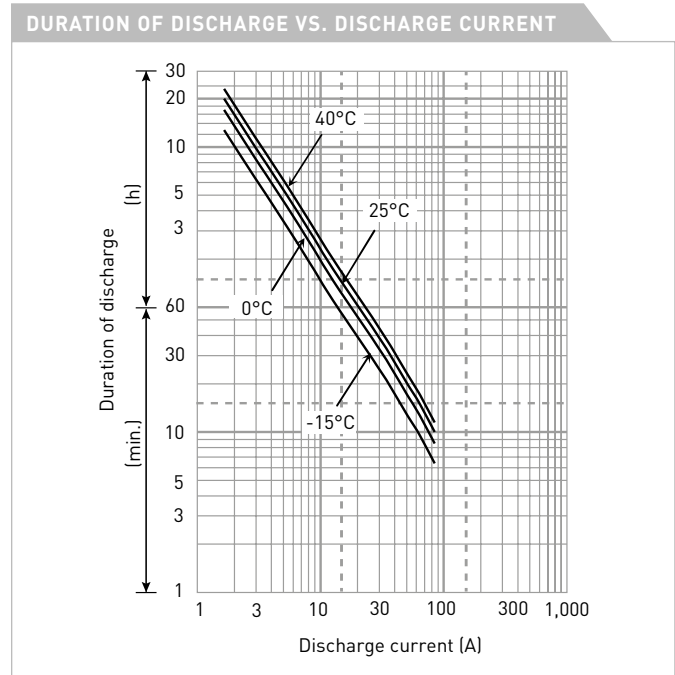

WATT TABLE (25°C)															[Wattage/battery]	
Cut-off	5min.	10min.	15min.	20min.	30min.	45min.	1h	1.5h	2h	3h	4h	5h	6h	10h	20h	
9.6V	1,254	948	732	635	457	328	268	187	149	107	86.6	69.5	60.5	36.9	19.8	
9.9V	1,182	928	721	630	452	322	262	182	148	106	85.4	68.3	60.1	36.9	19.8	
10.2V	1,115	899	706	619	443	321	259	170	147	105	84.2	67.7	59.7	36.9	19.8	
10.5V	1,051	868	684	603	433	314	256	168	146	104	83.6	67.4	59.2	36.9	19.8	
10.8V	1,001	823	663	590	421	281	233	162	137	99.4	82.5	67.1	58.8	36.9	19.8	

AMPERE TABLE (25°C)															[Ampere/battery]	
Cut-off	5min.	10min.	15min.	20min.	30min.	45min.	1h	1.5h	2h	3h	4h	5h	6h	10h	20h	
9.6V	113	84.6	63.7	54.8	39.1	27.9	22.8	15.8	12.6	9.00	7.25	5.80	5.10	3.10	1.65	
9.9V	106	82.9	62.7	54.4	38.6	27.4	22.2	15.5	12.5	8.85	7.15	5.70	5.05	3.10	1.65	
10.2V	100	80.3	61.4	53.4	37.9	27.1	22.0	14.4	12.4	8.75	7.05	5.65	5.00	3.10	1.65	
10.5V	94.3	77.5	59.5	52.0	37.0	26.8	21.8	14.3	12.3	8.70	6.98	5.63	4.95	3.10	1.65	
10.8V	89.8	73.5	57.7	50.9	36.0	24.0	19.8	13.7	11.6	8.35	6.90	5.60	4.90	3.10	1.65	

All mentioned values are average values

LC-V1233P

CHARGING METHOD (25°C)

Trickle use Control voltage: 13.6V - 13.8V
Initial current: 4.95A or smaller

CUT-OFF VOLTAGE

Discharge current	1.65A - 6.60A	6.60A - 16.5A	16.5A - 33.0A	33.0A - 66.0A	66.0A - 99.0A
Cut-off voltage	10.5V	10.2V	9.9V	9.3V	8.7V

INFLUENCE OF TEMPERATURE ON TRICKLE LIFE

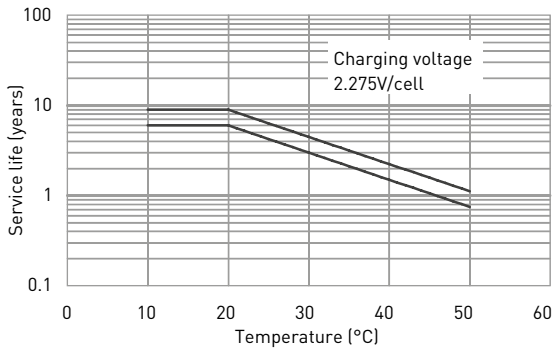

RESIDUAL CAPACITY TEST RESULT

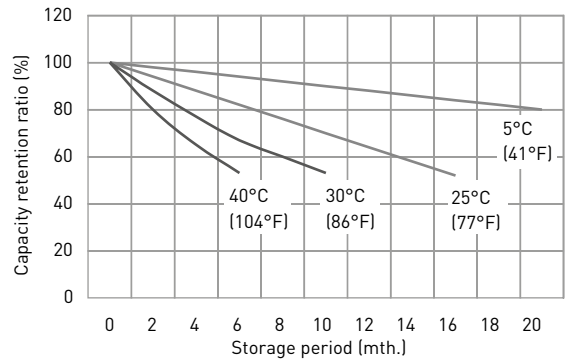

CONSTANT-VOLTAGE CONSTANT-CURRENT CHARGE CHARACTERISTICS FOR CYCLE USE

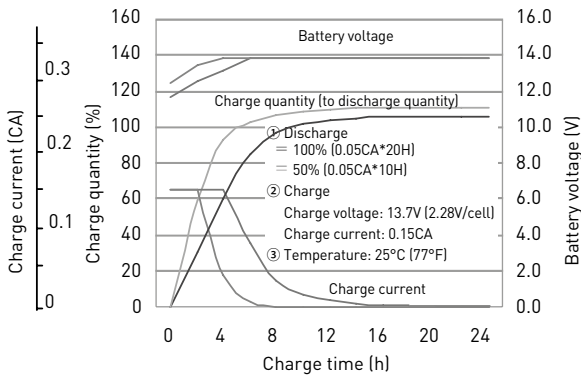

DISCHARGE CAPACITY BY TEMPERATURE AND BY DISCHARGE CURRENT

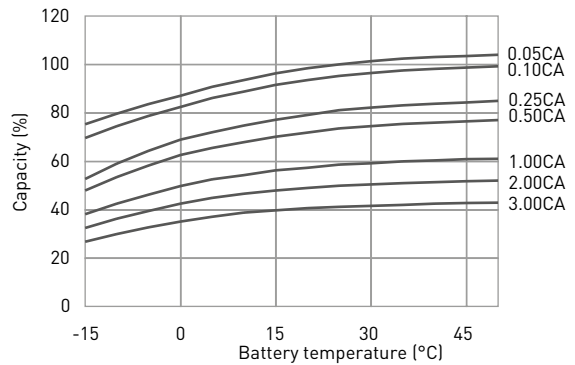

DISCHARGE CHARACTERISTICS

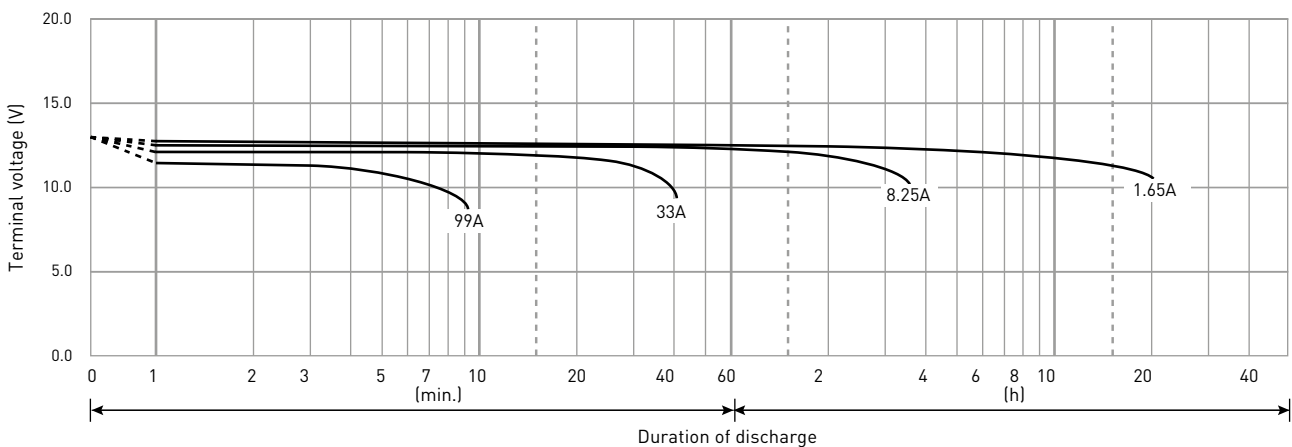

The data in this document are for descriptive purposes only and are not intended to make or imply any guarantee or warranty. Regarding handling and safety please consult our VRLA technical handbook chapter 1.